

CATALOGO

2020

RB
ROBERT
INDUSTRIES
PRODUZIONE ARTICOLI CASALINGHI



01

QUALITA'

02

PRATICITA'

03

DESIGN



+39 030 9924412



Quinzano d'Oglio - Brescia - Italia



info@robertindustries.it

WWW.ROBERTINDUSTRIES.IT

Giovane e dinamica con uno staff dall'esperienza pluriennale, ROBERT INDUSTRIES SRL opera nel settore della produzione di articoli per la casa, quali lo stendibiancheria, cavallo di battaglia, tavoli da stiro, scale e sgabelli per uso domestico.

Con attenzione alle esigenze dei vari mercati, nell'ottica del consumatore finale e con particolare rispetto delle normative vigenti che coinvolgono persone e ambiente, la R.I. ricopre un posto in prima fila non come spettatore ma come attivo partecipante di una realtà che impone etica e serietà.

Per questo ha sempre raggiunto il suo scopo, la soddisfazione dei suoi clienti.

Clienti con i quali ha dimostrato di saper collaborare e con i quali ha sempre trovato le giuste soluzioni a qualsiasi esigenza, clienti nuovi che con fiducia hanno cercato e trovato disponibilità e professionalità.

Dialogo e confronto sono le caratteristiche fondamentali che i nostri clienti non dimenticano e che danno continuamente l'input per proseguire senza lasciare nulla al caso. La R.I. può garantire prodotti soggetti a studio e verifiche periodiche per la sicurezza del consumatore, con l'utilizzo di materie prime testate nel rispetto dell'ambiente e non nocive per le persone che le utilizzano.

La R.I. presta particolare attenzione all'ambiente producendo energia pulita con un impianto fotovoltaico che copre l'intero fabbisogno per la produzione.

Lo stimolo a proseguire e a migliorare è dato dalle soddisfazioni che ogni giorno permettono a tutti coloro che collaborano con la R.I. di esprimere le proprie potenzialità al meglio, con coerenza, serietà e passione.

STENDIBIANCHERIA 2020

RB
**ROBERT
INDUSTRIES**
PRODUZIONE ARTICOLI CASALINGHI



01

QUALITA'

02

PRATICITA'

03

DESIGN



+39 030 9924412



Quinzano d'Oglio - Brescia - Italia



info@robertindustries.it

WWW.ROBERTINDUSTRIES.IT

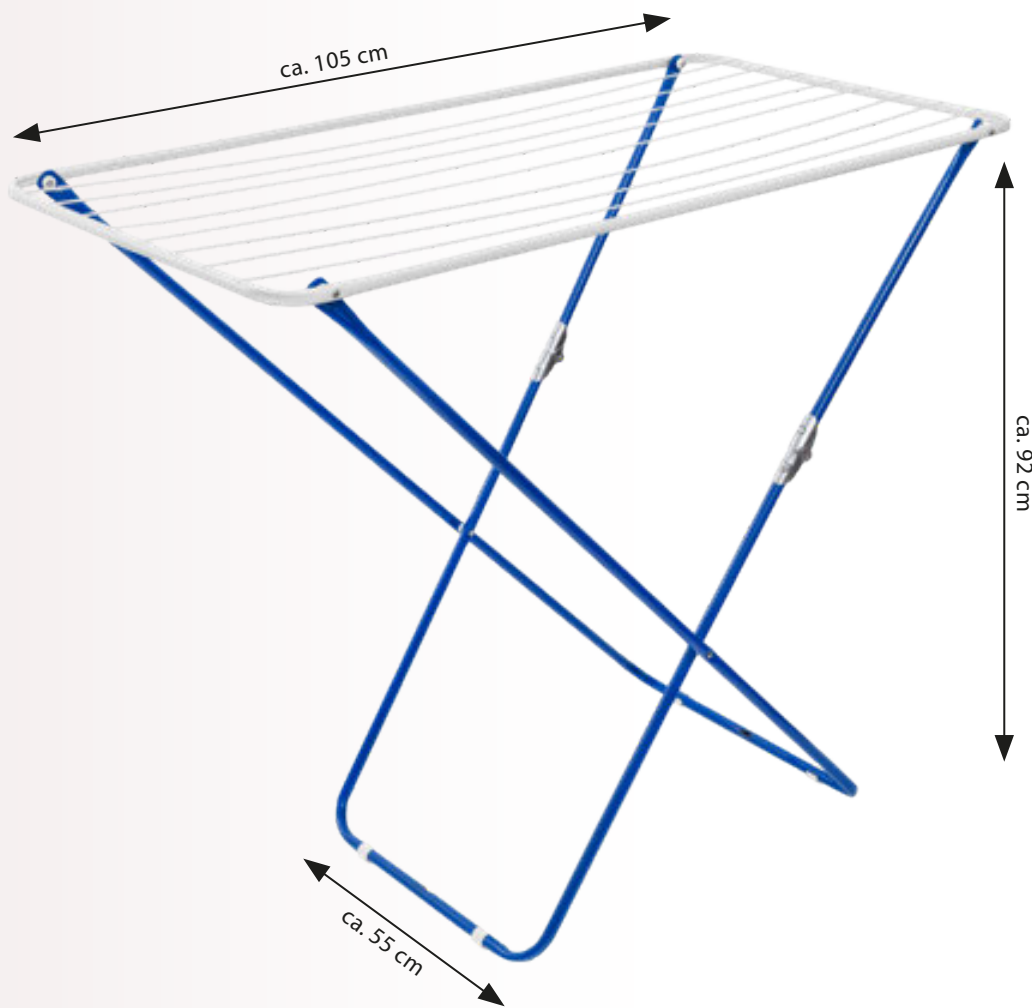
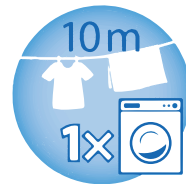

ACCIAIO VERNICIATO
PAINTED STEEL

Item	Weight Item / Master	Pcs. in Master	Packed Item Size a x b x c (cm)	Master Size a x b x c (cm)	Pallet Height	Pcs. in Pallet	Pcs. in 40' HC Container	Pcs. in Truc k	EAN
NORMAL 105 VB	2,20/18,10	8	128x55x3	130x60x15	146	80	4880	5280	8015010105029

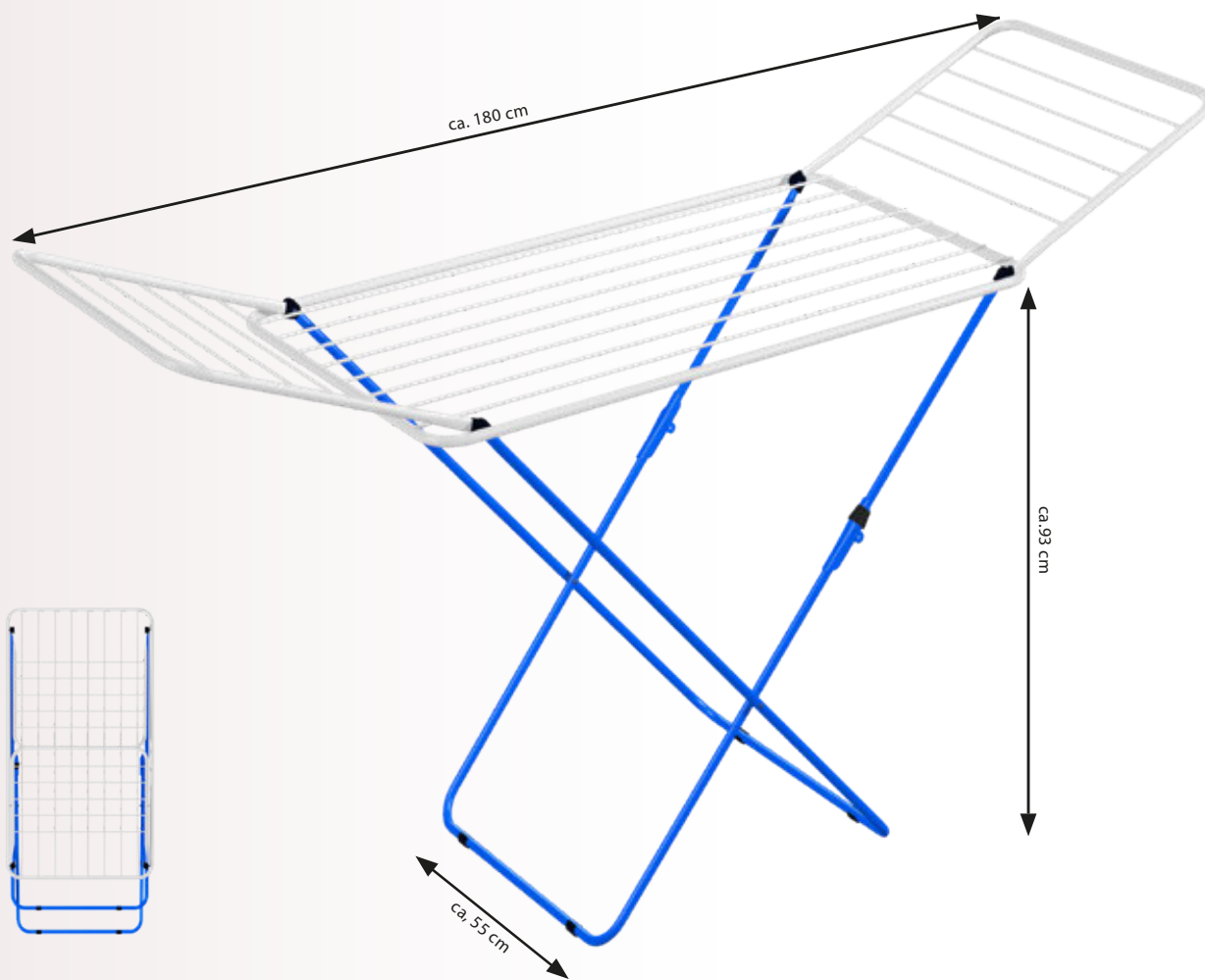

ACCIAIO VERNICIATO
PAINTED STEEL

Item	Weight Item / Master	Pcs. in Master	Packed Item Size a x b x c (cm)	Master Size a x b x c (cm)	Pallet Height	Pcs. in Pallet	Pcs. in 40' HC Container	Pcs. in Truck	EAN
LINEN 18 - 103 VB	2,70/17,00	6	128x55x4	130x60x13	146	66	4002	4356	8015010103025

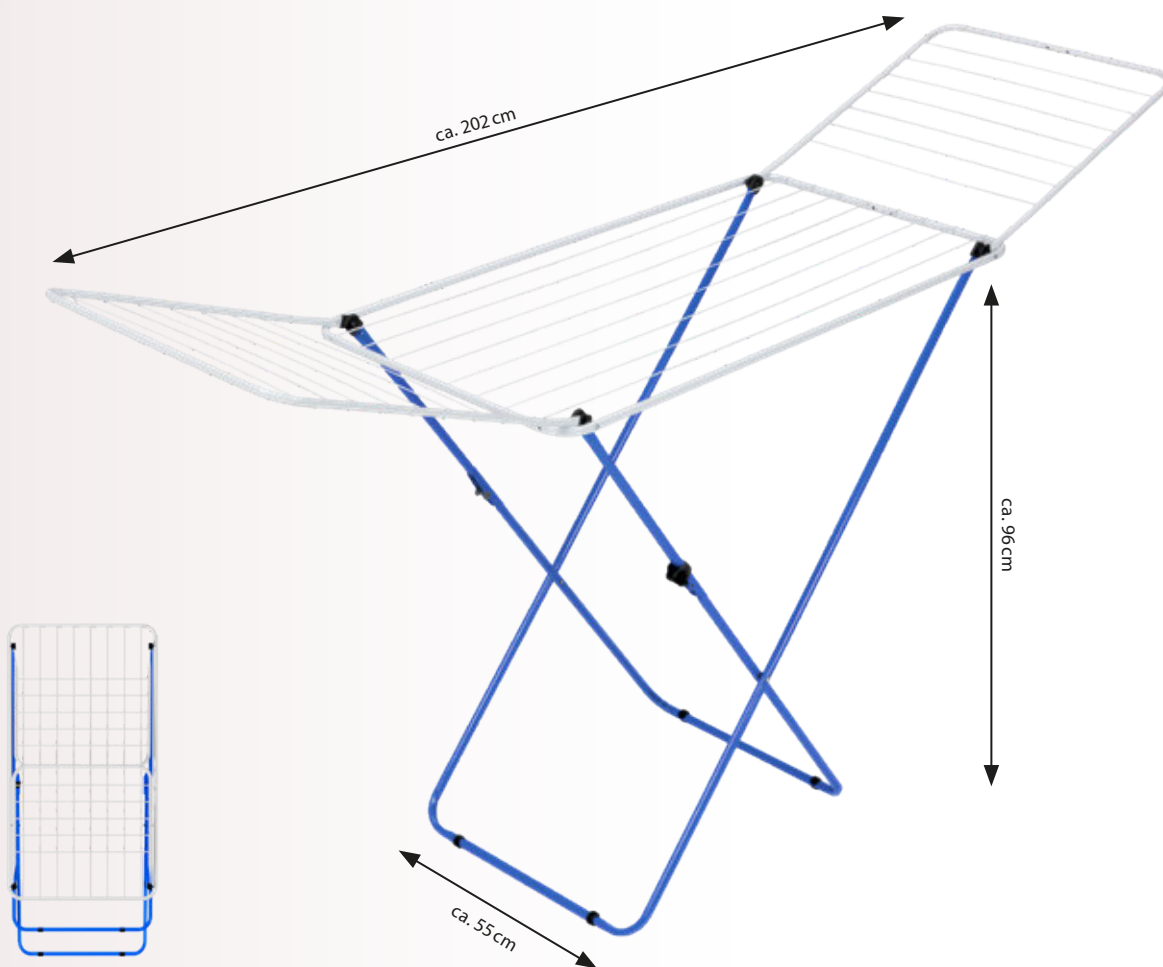

ACCIAIO VERNICIATO
PAINTED STEEL

Item	Weight Item / Master	Pcs. in Master	Packed Item Size a x b x c (cm)	Master Size a x b x c (cm)	Pallet Height	Pcs. in Pallet	Pcs. in 40' HC Container	Pcs. in Truc k	EAN
LINEN 20 - 106 VB	3,40/20,40	6	130x55x5	130x60x19	146	54	3150	3564	8015010106026

3in1



1

UTILIZZABILE CON O SENZA ALI.
USE AS COMPLETE CLOTHES AIRER WITH OR WITHOUT WINGS.

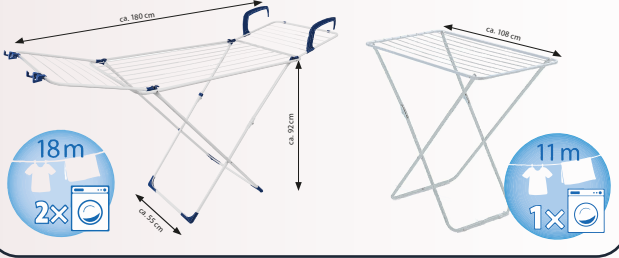

2

USARE LE ALI CON I GANCI COME STENDIBIANCHERIA DA RADIATORE O BALCONE.
USE THE WINGS WITH HANGER AS A RADIATOR OR BALCONY AIRER.



3

UTILIZZARE LE ALI UNITE PER COMPORRE LO STENDIBIANCHERIA DA VASCA.
USE BOTH WINGS PLUGGED TOGETHER AS BATHTUB AIRER.



ACCIAIO VERNICIATO
PAINTED STEEL

Item	Weight Item / Master	Pcs. in Master	Packed Item Size a x b x c (cm)	Master Size a x b x c (cm)	Pallet Height	Pcs. in Pallet	Pcs. in 40' HC Container	Pcs. in Truck	EAN
LINEN 3 IN 1	2,80/17,80	5	129x55x5	130x63x17	146	45	2700	2970	9007741016728

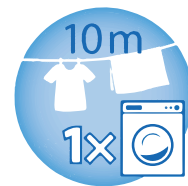

GANCI MOBILI PER
ADATTARSI AD OGNI
ESIGENZA.
HANGERS ARE MOVABLE
FOR ADJUSTING TO YOUR
NEEDS.

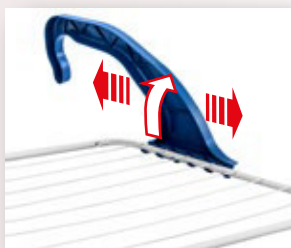

IDEALE PER BALCONI.
IDEAL FOR HANGING ON BALCONIES.

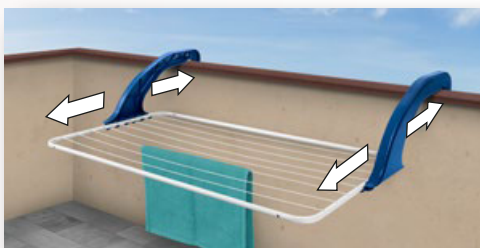

ACCIAIO VERNICIATO
PAINTED STEEL

Item	Weight Item / Master	Pcs. in Master	Packed Item Size a x b x c (cm)	Master Size a x b x c (cm)	Pallet Height	Pcs. in Pallet	Pcs. in 40' HC Container	Pcs. in Truc k	EAN
BALCONY 10 108/VDP	1,20/15,50	12	108x55x3	110x60x40	128	48	3480	3168	8015033108144

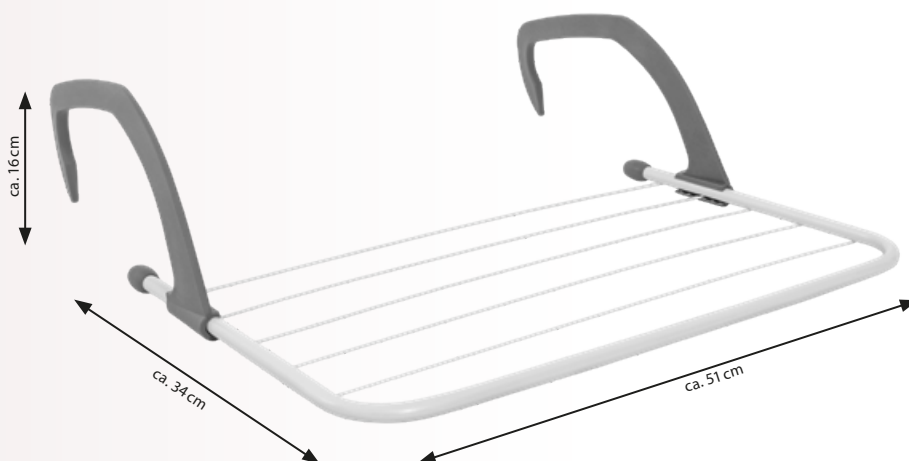

IDEALE PER ESSERE APPESO
 A TERMOSIFONI.
 I GANCI SONO MOBILI PER ADATTARSI ALLE
 TUE ESIGENZE.

IDEAL FOR HANGING ON RADIATORS.
 HANGERS ARE MOVABLE FOR ADJUSTING
 TO YOUR NEEDS.



ACCIAIO VERNICIATO
PAINTED STEEL

Item	Weight Item / Master	Pcs. in Master	Packed Item Size a x b x c (cm)	Master Size a x b x c (cm)	Pallet Height	Pcs. in Pallet	Pcs. in 40' HC Container	Pcs. in Truc k	EAN
RADIATORE 1011/VDS	0,445/7,00	15	51x35x2	53x35x24	181	420	22200	13860	8015033101121

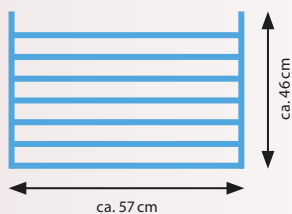
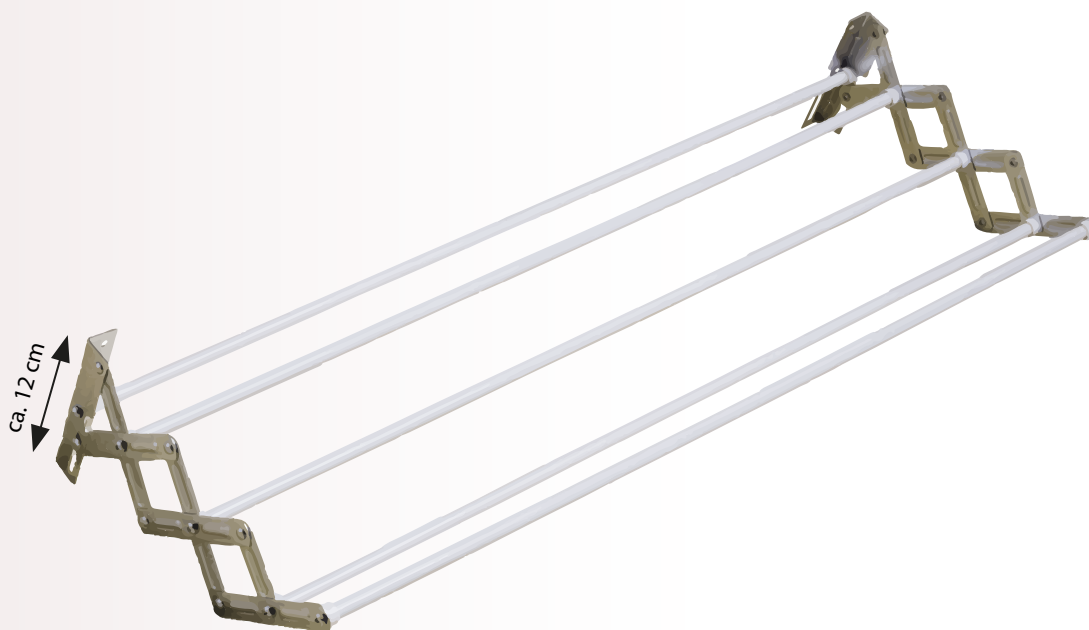

ACCIAIO PLASTIFICATO
 PLASTICIZED STEEL

Item	Weight Item / Master	Pcs. in Master	Packed Item Size a x b x c (cm)	Master Size a x b x c (cm)	Pallet Height	Pcs. in Pallet	Pcs. in 40' HC Container	Pcs. in Truck	EAN
ESTENSIBILE 60 - 112/060VS	1,00/3,00	6	60x20x10	61x40x30	139	96	6510	6336	8015010112065

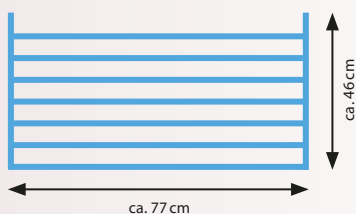

ACCIAIO PLASTIFICATO
PLASTICIZED STEEL

Item	Weight Item / Master	Pcs. in Master	Packed Item Size a x b x c (cm)	Master Size a x b x c (cm)	Pallet Height	Pcs. in Pallet	Pcs. in 40' HC Container	Pcs. in Truck	EAN
ESTENSIBILE 80 - 112/080VS	1,20/9,20	6	80x20x10	81x40x30	139	72	4800	4752	8015010112089

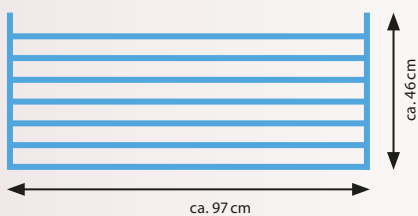
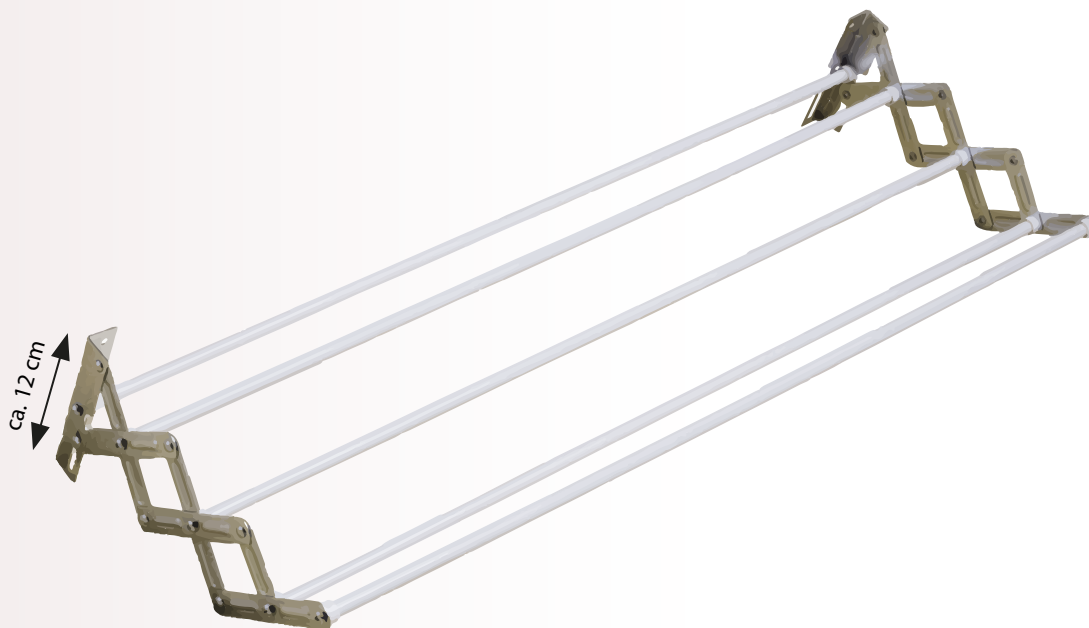

ACCIAIO PLASTIFICATO
 PLASTICIZED STEEL

Item	Weight Item / Master	Pcs. in Master	Packed Item Size a x b x c (cm)	Master Size a x b x c (cm)	Pallet Height	Pcs. in Pallet	Pcs. in 40' HC Container	Pcs. in Truck	EAN
ESTENSIBILE 100 - 112/100VS	1,40/10,40	6	100x20x10	101x40x30	119	48	3760	3168	8015010112102

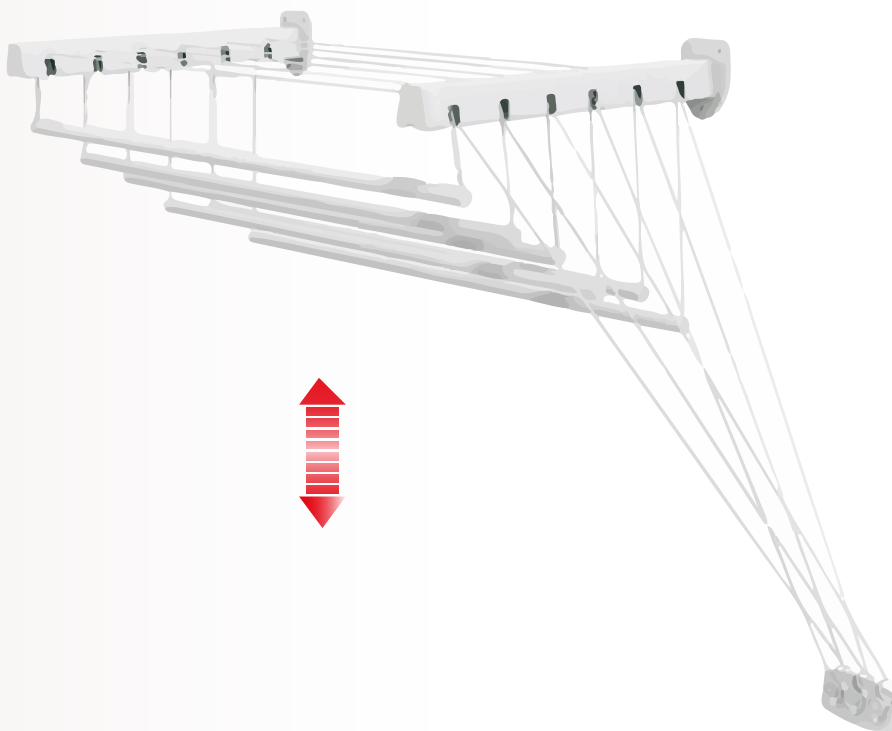

posa a **PARETE**

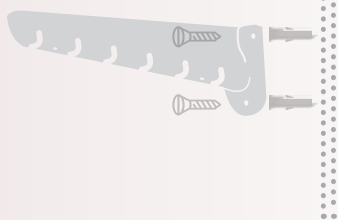

posa a **SOFFITTO**

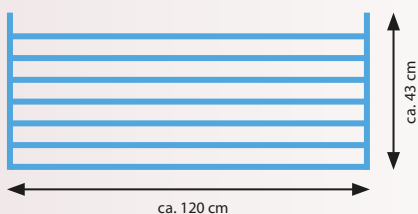
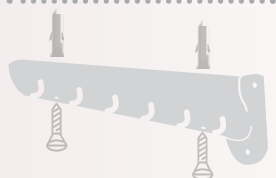

ACCIAIO PLASTIFICATO
PLASTICIZED STEEL

Item	Weight Item / Master	Pcs. in Master	Packed Item Size a x b x c (cm)	Master Size a x b x c (cm)	Pallet Height	Pcs. in Pallet	Pcs. in 40' HC Container	Pcs. in Truck	EAN
SALISCENDI 120 - 111/120VS	2,5	1	122x10x5	122X10X5	141	198	11330	12672	8015010111129

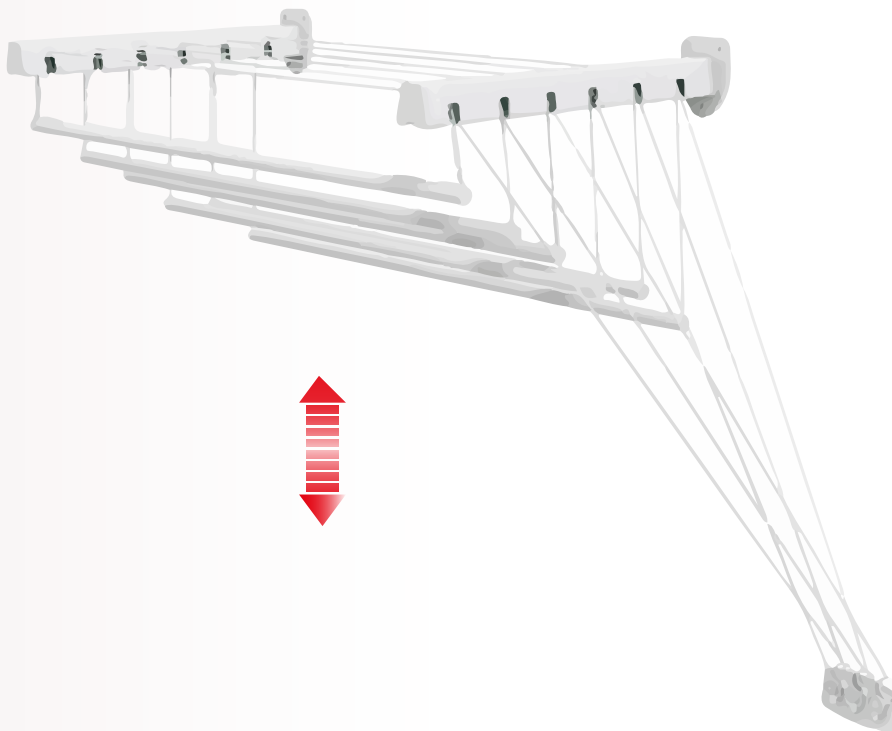

posa a **PARETE**

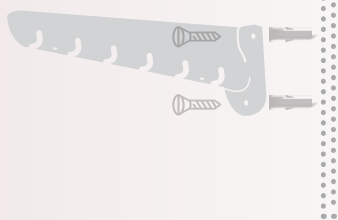

posa a **SOFFITTO**

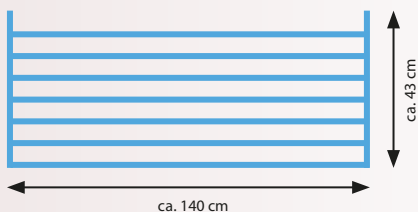
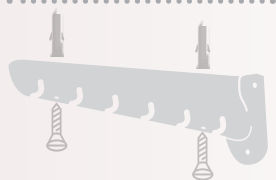

ACCIAIO PLASTIFICATO
PLASTICIZED STEEL

Item	Weight Item / Master	Pcs. in Master	Packed Item Size a x b x c (cm)	Master Size a x b x c (cm)	Pallet Height	Pcs. in Pallet	Pcs. in 40' HC Container	Pcs. in Truck	EAN
SALISCENDI 140 - 111/140VS	3,0	1	142x10x5	142X10X5	161	192	8360	6336	8015010111143

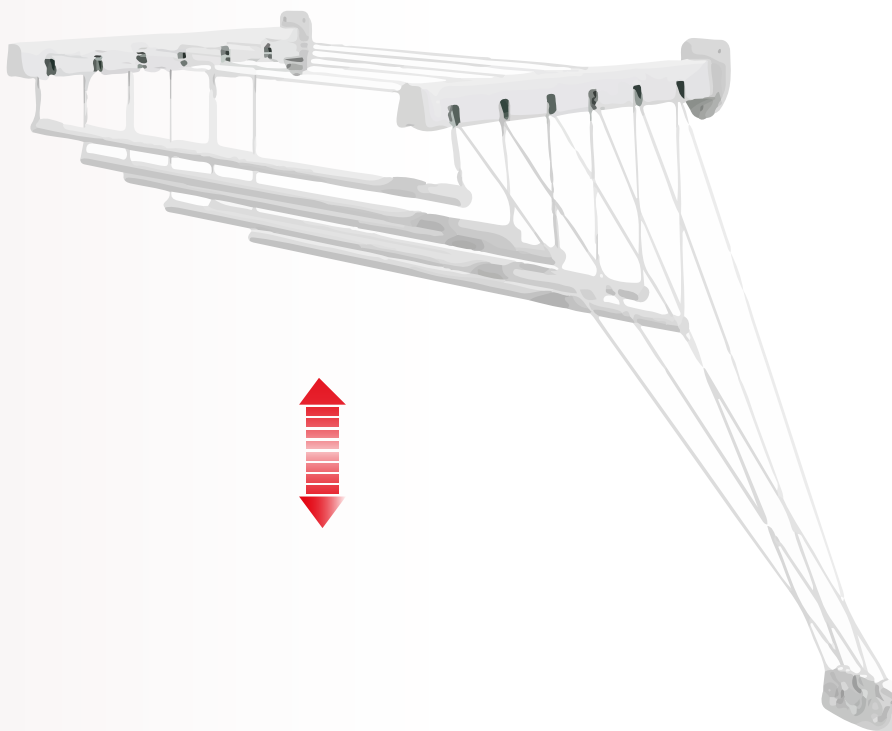

posa a **PARETE**

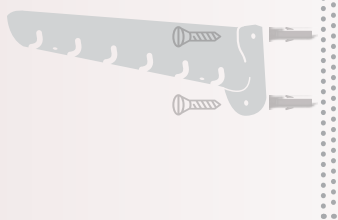

posa a **SOFFITTO**

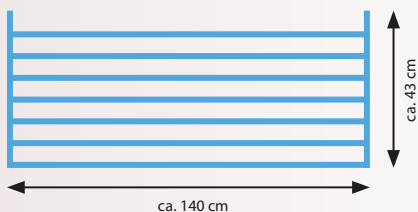
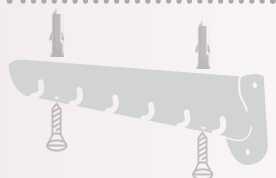

ACCIAIO PLASTIFICATO
PLASTICIZED STEEL

Item	Weight Item / Master	Pcs. in Master	Packed Item Size a x b x c (cm)	Master Size a x b x c (cm)	Pallet Height	Pcs. in Pallet	Pcs. in 40' HC Container	Pcs. in Truck	EAN
SALISCENDI 160 - 111/160VS	3,5	1	162x10x5	162X10X5	181	192	7600	6336	8015010111167

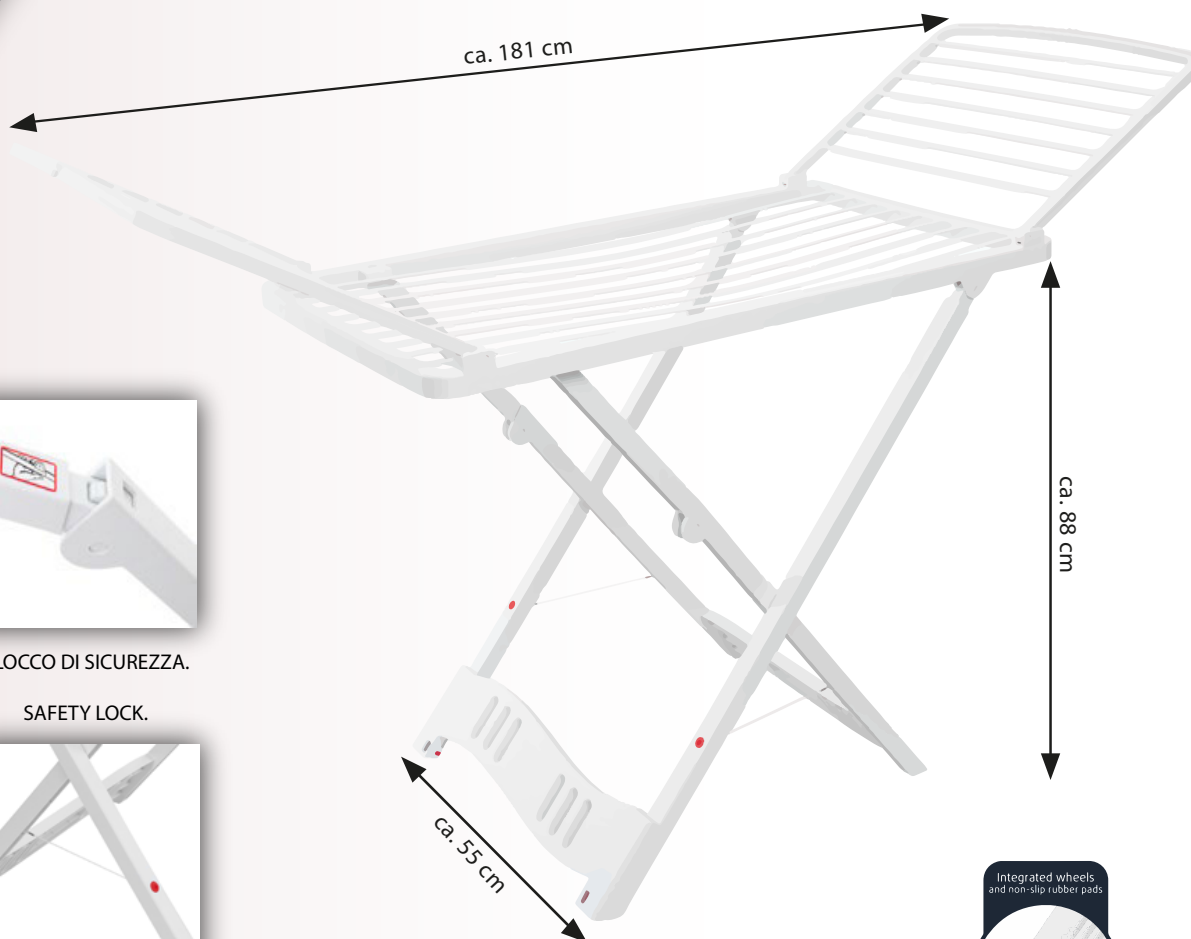

BLOCCO DI SICUREZZA.

SAFETY LOCK.



CORDE PER UNA
MAGGIORE SICUREZZA E
STABILITA'.

HOOKS AND HOLDING
CHORDS FOR MORE
STABILITY.

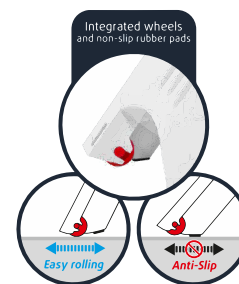

RESINA
RESIN

Item	Weight Item / Master	Pcs. in Master	Packed Item Size a x b x c (cm)	Master Size a x b x c (cm)	Pallet Height	Pcs. in Pallet	Pcs. in 40' HC Container	Pcs. in Truck	EAN
RESINA 20 CS92066	4,50	1	124x58x8	124x58x8	255	60	1110	1320	9007741014922



ECO 6

ROBERT INDUSTRIES

2020

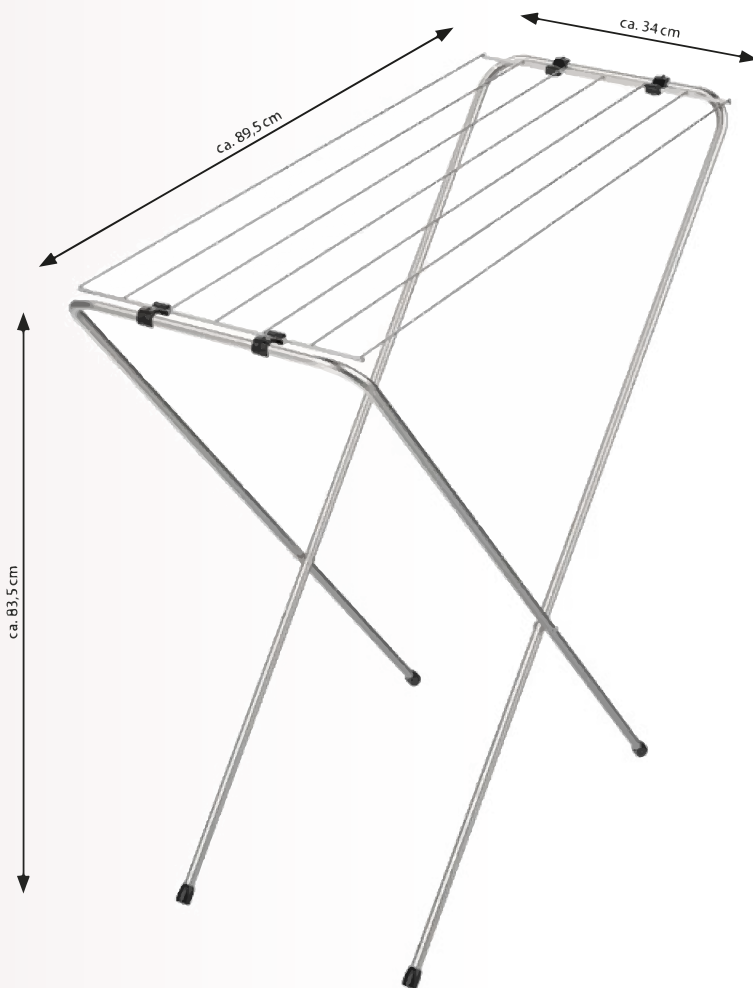

ACCIAIO VERNICIATO
PAINTED STEEL

Item	Weight Item / Master	Pcs. in Master	Packed Item Size a x b x c (cm)	Master Size a x b x c (cm)	Pallet Height	Pcs. in Pallet	Pcs. in 40' HC Container	Pcs. in Truck	EAN
ECO 6 CS96014	1,1/23,90	20	113x34x2	115x35x20	131	120	9200	7920	9007741018388



ELEGANT SILVER 18

ROBERT INDUSTRIES

2020

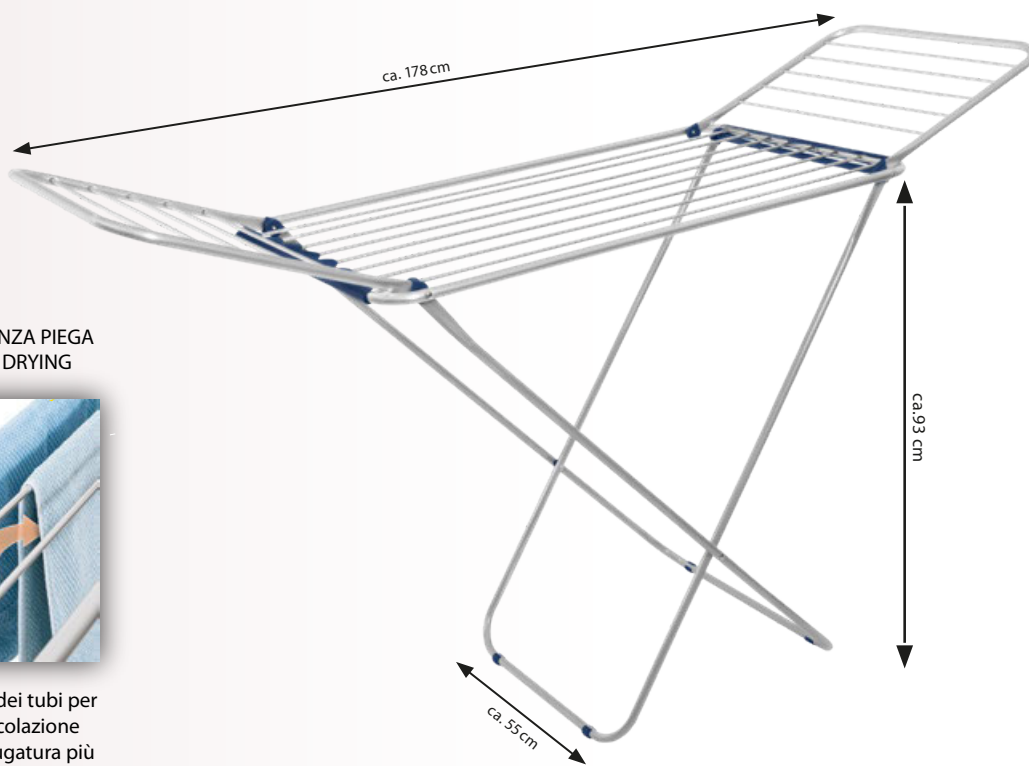

ASCIUGATURA SENZA PIEGA
WRINKLE FREE DRYING



Grande diametro dei tubi per una migliore circolazione dell'aria e un'asciugatura più rapida.

Extra thick tubes for better air circulation and faster drying.

ALUMINIUM

Top in Alluminio - Gambe in Acciaio
Top Aluminium - Steel Legs

ALLUMINIO - ACCIAIO
ALUMINIUM - STEEL

Item	Weight Item / Master	Pcs. in Master	Packed Item Size a x b x c (cm)	Master Size a x b x c (cm)	Pallet Height	Pcs. in Pallet	Pcs. in 40' HC Container	Pcs. in Truck	EAN
ELEGANT SILVER 18 CS92730	1,80/13,00	6	130x55x3	132x61x16	148	48	3048	3168	9007741010221



ELEGANT COLOR 18

ROBERT INDUSTRIES

2020

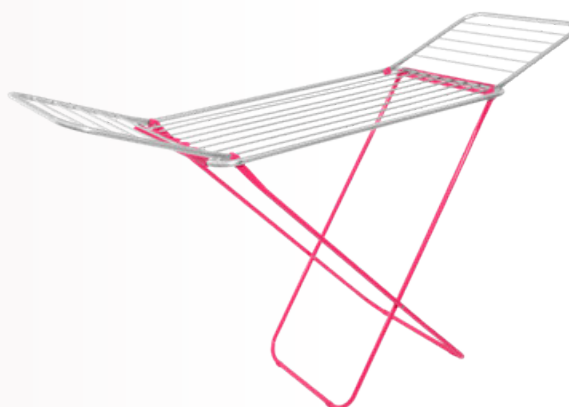
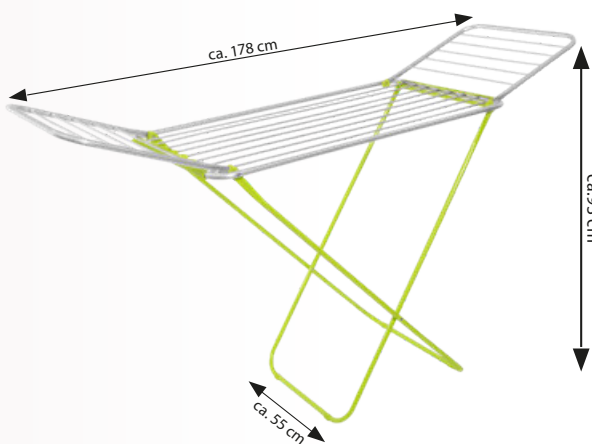
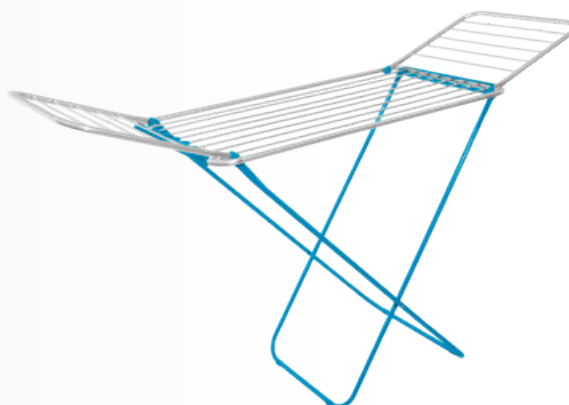

ASCIUGATURA SENZA PIEGA
WRINKLE FREE DRYING



Grande diametro dei tubi per una migliore circolazione dell'aria e un'asciugatura più rapida.

Extra thick tubes for better air circulation and faster drying.

DUE PEZZI PER COLORE NELLA SCATOLA
TWO PIECES FOR COLOR IN THE BOX

ALUMINIUM

Top in Alluminio - Gambe in Acciaio
Top Aluminium - Steel Legs

ALLUMINIO - ACCIAIO
ALUMINIUM - STEEL

Item	Weight Item / Master	Pcs. in Master	Packed Item Size a x b x c (cm)	Master Size a x b x c (cm)	Pallet Height	Pcs. in Pallet	Pcs. in 40' HC Container	Pcs. in Truck	EAN
ELEGANT COLOR 18 CS927331	1,80/13,00	6	130x55x3	132x61x16	148	48	3048	3168	9007741018210

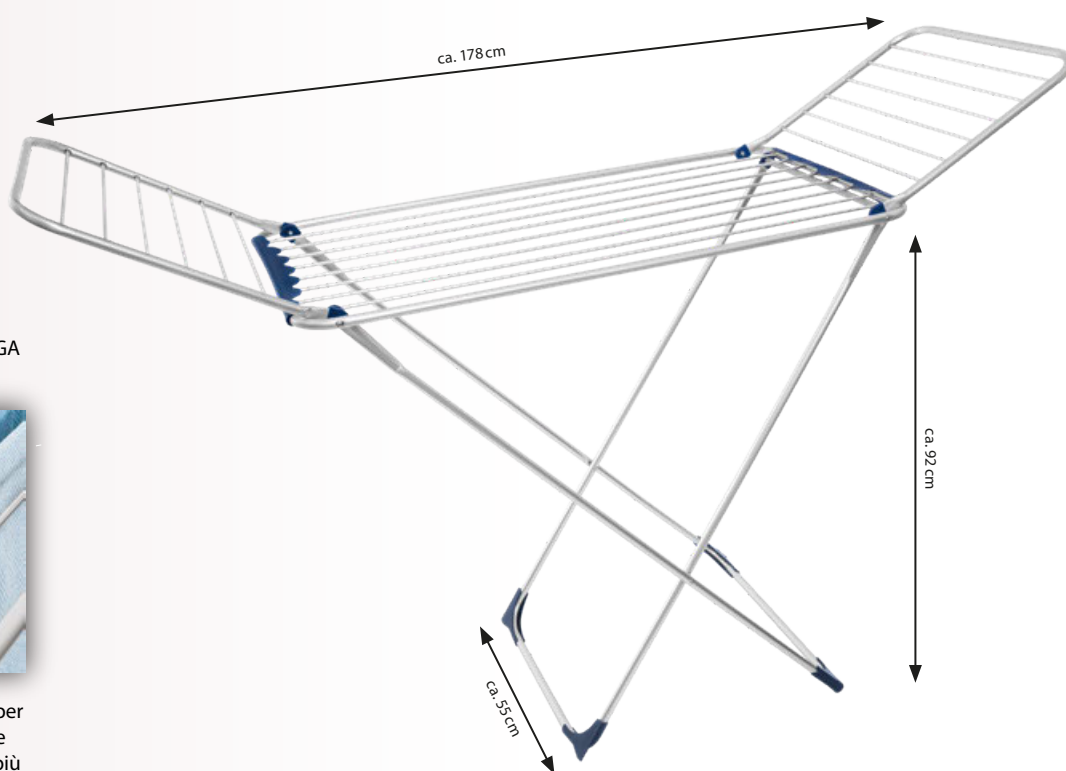

ASCIUGATURA SENZA PIEGA
WRINKLE FREE DRYING











Grande diametro dei tubi per una migliore circolazione dell'aria e un'asciugatura più rapida.

Extra thick tubes for better air circulation and faster drying.

100 %
ALUMINIUM



ALLUMINIO
ALUMINIUM

Item	Weight Item / Master	Pcs. in Master	Packed Item Size a x b x c (cm)	Master Size a x b x c (cm)	Pallet Height	Pcs. in Pallet	Pcs. in 40' HC Container	Pcs. in Truck	EAN
									
URBAN 20 CS736	1,50/11,50	6	130x55x3	132x61x16	148	48	3048	3168	9007741018227



ASCIUGATURA SENZA PIEGA
WRINKLE FREE DRYING

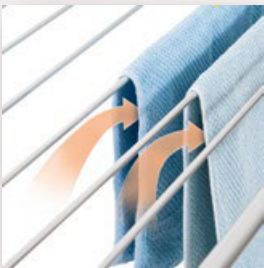

Grande diametro dei tubi per una migliore circolazione dell'aria e un'asciugatura più rapida.

Extra thick tubes for better air circulation and faster drying.

IDEALE PER BALCONI
IDEAL FOR HANGING ON
BALCONIES

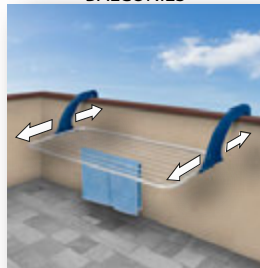









Ganci mobili per adattarsi ad ogni esigenza.

Hangers are movable for adjusting to your needs.

100 %
ALUMINIUM



ALLUMINIO
ALUMINIUM

Item	Weight Item / Master	Pcs. in Master	Packed Item Size a x b x c (cm)	Master Size a x b x c (cm)	Pallet Height	Pcs. in Pallet	Pcs. in 40' HC Container	Pcs. in Truck	EAN
									
ELEGANT BALCONY 10 CS92727	0,70/6,70	6	103x54x4	105x57x20	176	72	3408	3168	9007741018234

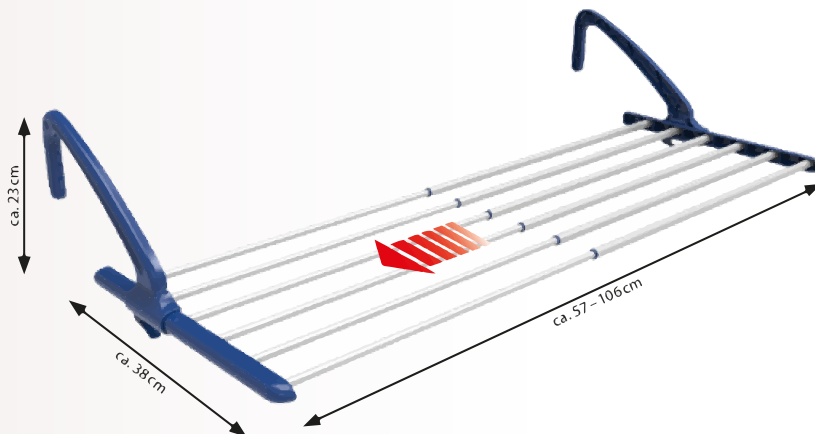

ASCIUGATURA SENZA PIEGA
WRINKLE FREE DRYING

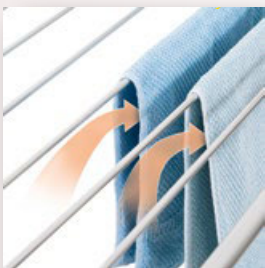

Grande diametro dei tubi per una migliore circolazione dell'aria e un'asciugatura più rapida.

Extra thick tubes for better air circulation and faster drying.

IDEALE PER BALCONI
IDEAL FOR HANGING ON
BALCONIES

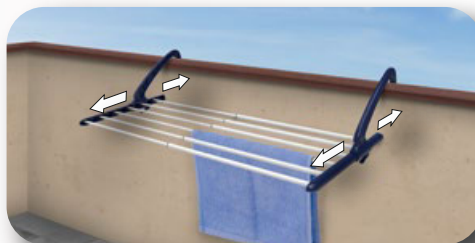

Ganci mobili per adattarsi ad ogni esigenza.

Hangers are movable for adjusting to your needs.

ALLUNGABILE SENZA
BARRA CENTRALE, ADATTO
PER CAPI MOLTO GRANDI.

EXTENDABLE WITHOUT
MIDBAR, WELL SUITED FOR
VERY LARGE GARMENTS.

100 %
ALUMINIUM



ALLUMINIO
ALUMINIUM

Item	Weight Item / Master	Pcs. in Master	Packed Item Size a x b x c (cm)	Master Size a x b x c (cm)	Pallet Height	Pcs. in Pallet	Pcs. in 40' HC Container	Pcs. in Truck	EAN
BALCONFLEX MONO CS92183	0,70/3,50	4	58x38x7	59x39x20	168	80	3830	2640	9007741012577



EASYFLEX

ROBERT INDUSTRIES

2020

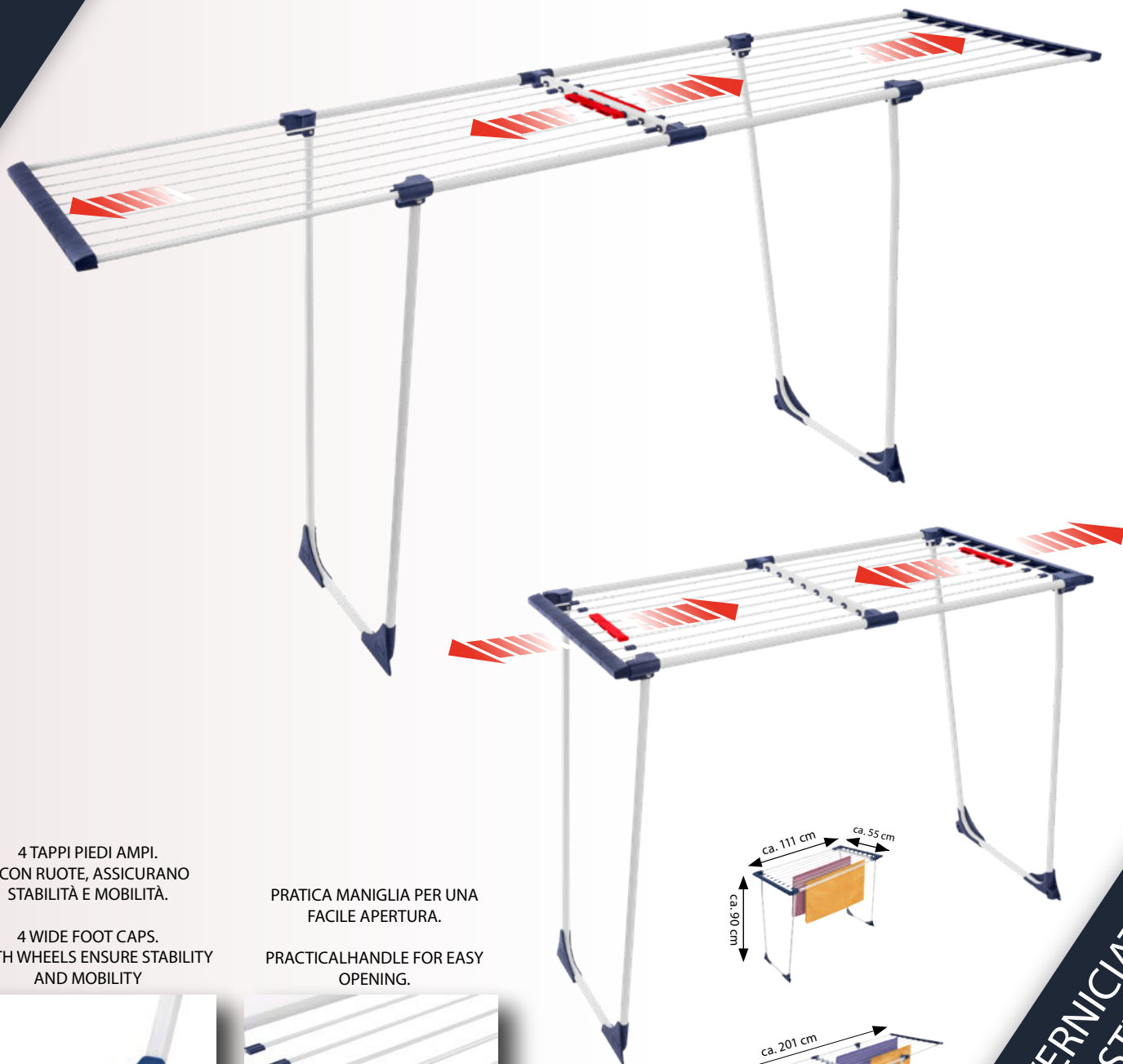

4 TAPPI PIEDI AMPI.
2 CON RUOTE, ASSICURANO
STABILITÀ E MOBILITÀ.

4 WIDE FOOT CAPS.
2 WITH WHEELS ENSURE STABILITY
AND MOBILITY

PRATICA MANIGLIA PER UNA
FACILE APERTURA.

PRACTICAL HANDLE FOR EASY
OPENING.

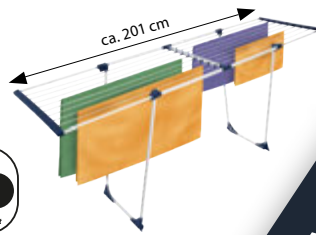
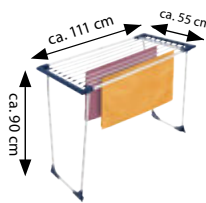
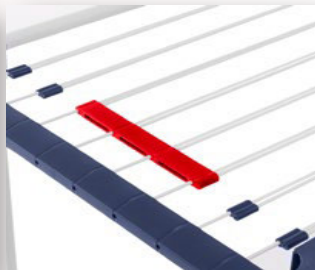

ACCIAIO VERNICIATO
PAINTED STEEL

Item	Weight Item / Master	Pcs. in Master	Packed Item Size a x b x c (cm)	Master Size a x b x c (cm)	Pallet Height	Pcs. in Pallet	Pcs. in 40' HC Container	Pcs. in Truck	EAN
EASYFLEX CS92162	4,10/18,10	4	111x55x8	113x56x24	133	36	2112	2304	9007741010252



CASAFLEX

ROBERT INDUSTRIES

2020

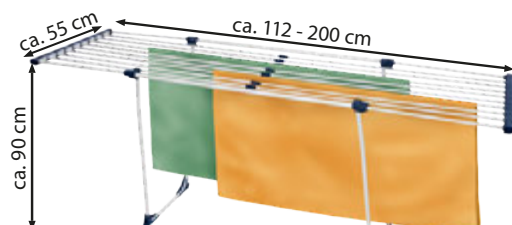
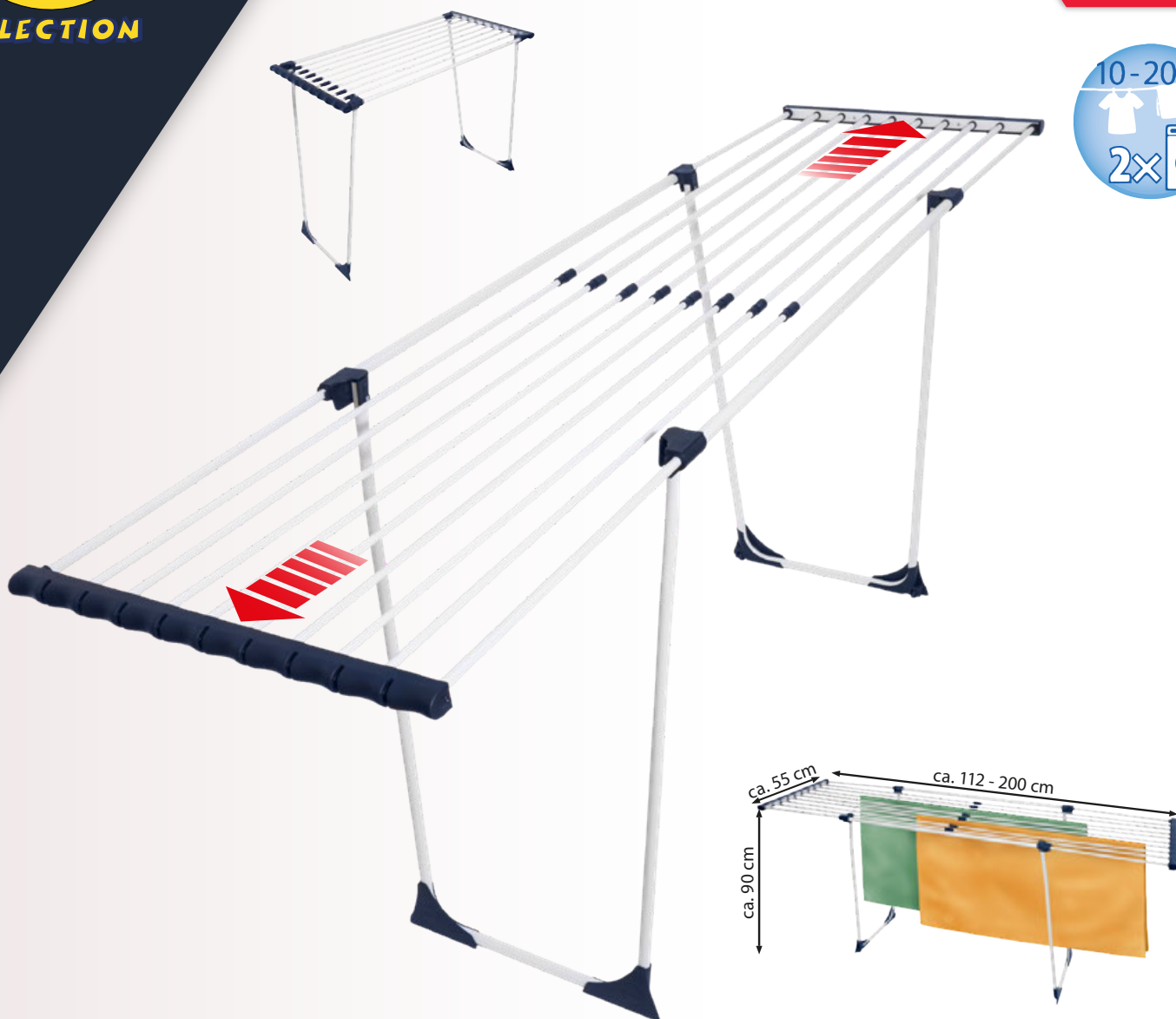

4 TAPPI PIEDI AMPI.
2 CON RUOTE, ASSICURANO
STABILITÀ E MOBILITÀ.

4 WIDE FOOT CAPS.
2 WITH WHEELS ENSURE STABILITY
AND MOBILITY

PORTA CALZE INTEGRATO.

INTEGRATED SOCK HOLDER.

GRANDE DIAMETRO DEI TUBI PER
UNA MIGLIORE CIRCOLAZIONE
DELL'ARIA E UN' ASCIUGATURA
PIU' RAPIDA.

EXTRA THICK TUBES FOR BETTER
AIR CIRCULATION AND FASTER
DRYING.



ACCIAIO VERNICIATO
PAINTED STEEL

Item	Weight Item / Master	Pcs. in Master	Packed Item Size a x b x c (cm)	Master Size a x b x c (cm)	Pallet Height	Pcs. in Pallet	Pcs. in 40' HC Container	Pcs. in Truck	EAN
CASAFLEX CS92179	4,90/20,10	4	114x55x6	115x57x20	133	36	2040	2304	9007741012553



EIFFEL 26

ROBERT INDUSTRIES

2020



AUTOMATIC

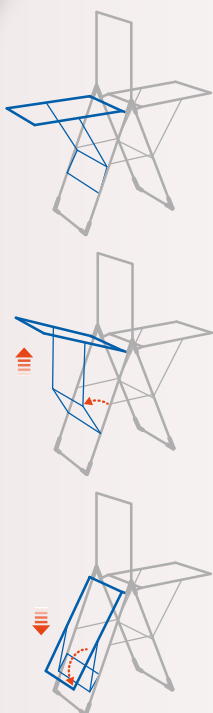

4 SUPPORTI PORTA SCARPE INTEGRATI.

4 INTEGRATED SHOE HOLDER.

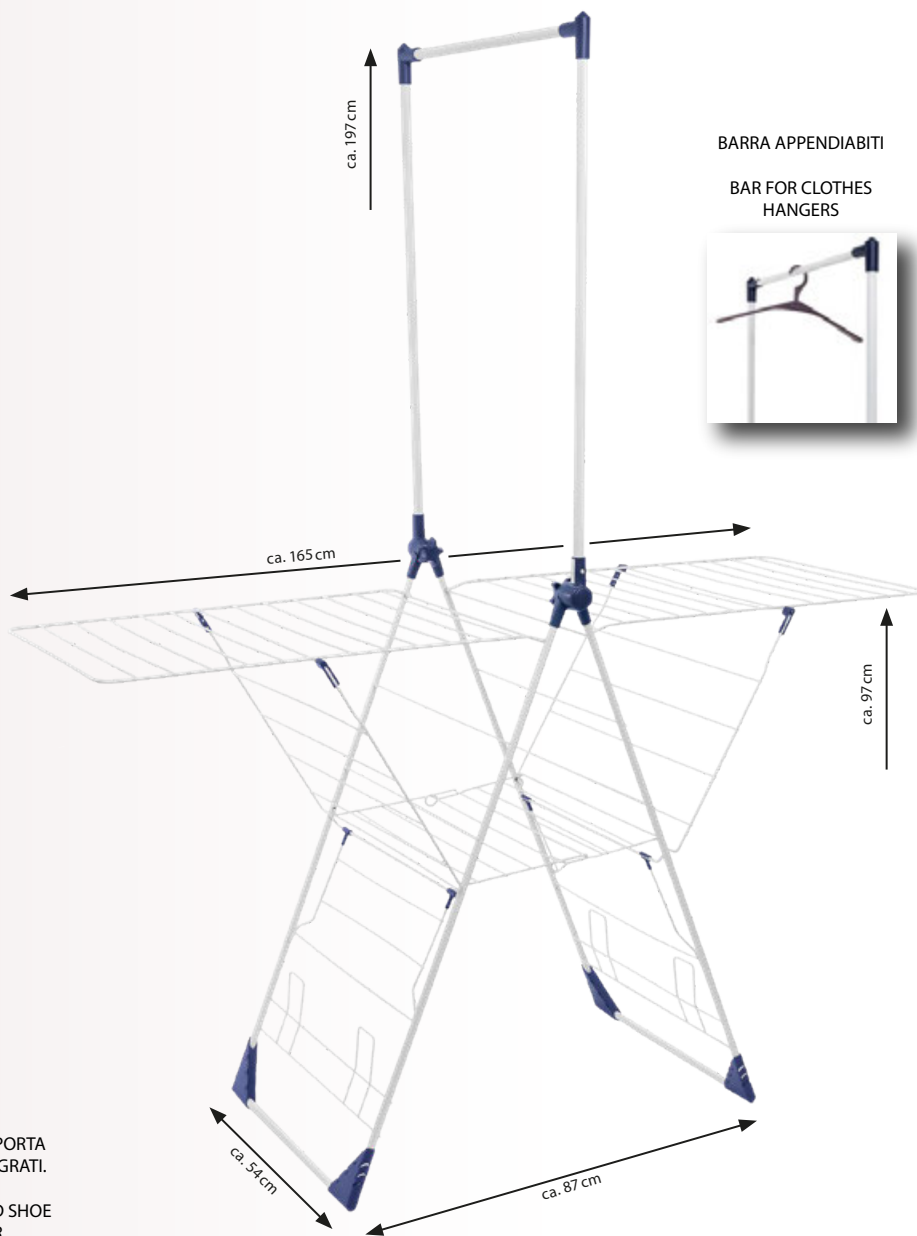

BARRA APPENDIBILI

BAR FOR CLOTHES HANGERS



ACCIAIO VERNICIATO
PAINTED STEEL

Item	Weight Item / Master	Pcs. in Master	Packed Item Size a x b x c (cm)	Master Size a x b x c (cm)	Pallet Height	Pcs. in Pallet	Pcs. in 40' HC Container	Pcs. in Truck	EAN
EIFFEL 26 CS92276	5,60/19,10	3	113X58X7	114X61X23	132	24	1542	1584	9007741014700

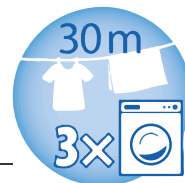

CERNIERE ROBUSTE E FACILI DA USARE.

ROBUST AND EASY RUNNING HINGES.



CHIUSURA PIATTA PER UN FACILE TRASPORTO E MINIMO INGOMBRO.

FOLDING FULLY FLAT FOR EASY STORAGE AND TRANSPORTATION.



UTILIZZABILE META PER SALVARE SPAZIO..

CAN ALSO BE USED WITH HALF SIDE UNFOLDED FOR SPACE SAVING MOUNTING.



ADATTO PER CABINE DOCCIA.

SUITABLE FOR SHOWER CABINS.



ACCIAIO VERNICIATO
PAINTED STEEL

Item	Weight Item / Master	Pcs. in Master	Packed Item Size a x b x c (cm)	Master Size a x b x c (cm)	Pallet Height	Pcs. in Pallet	Pcs. in 40' HC Container	Pcs. in Truck	EAN
ADAPT 3 CS92205	3,60/15,30	4	132x72x3	134x73x10	152	48	3400	1584	9007741018364



CERNIERE ROBUSTE E FACILI DA USARE.

ROBUST AND EASY RUNNING HINGES.

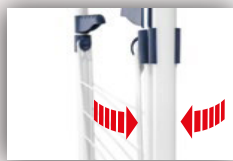

CHIUSURA PIATTA PER UN FACILE TRASPORTO E MINIMO INGOMBRO.

FOLDING FULLY FLAT FOR EASY STORAGE AND TRANSPORTATION.



UTILIZZABILE META PER SALVARE SPAZIO..

CAN ALSO BE USED WITH HALF SIDE UNFOLDED FOR SPACE SAVING MOUNTING.



ADATTO PER CABINE DOCCIA.

SUITABLE FOR SHOWER CABINS.



**ACCIAIO VERNICIATO
PAINTED STEEL**

Item	Weight Item / Master	Pcs. in Master	Packed Item Size a x b x c (cm)	Master Size a x b x c (cm)	Pallet Height	Pcs. in Pallet	Pcs. in 40' HC Container	Pcs. in Truck	EAN
ADAPT 4 CS92206	4,40/19,30	4	167x72x3	168x73x10	186	48	2660	1584	9007741018371



CERNIERE ROBUSTE E FACILI DA USARE.

ROBUST AND EASY RUNNING HINGES.



COMPRESI 2 SUPPORTI PER 8 APPENDINI.

INCLUDING 2 HOLDERS FOR UP TO 8 CLOTHES HANGERS.



CHIUSURA PIATTA PER UN FACILE TRASPORTO E MINIMO INGOMBRO.

FOLDING FULLY FLAT FOR EASY STORAGE AND TRANSPORTATION.











RUOTE ROTATABILI A 360° CON FRENI.

360° ROTATABLE WHEELS WITH BRAKES.



**ACCIAIO VERNICIATO
PAINTED STEEL**

Item	Weight Item / Master	Pcs. in Master	Packed Item Size a x b x c (cm)	Master Size a x b x c (cm)	Pallet Height	Pcs. in Pallet	Pcs. in 40' HC Container	Pcs. in Truck	EAN
									
ATHLETIC 3	3,70/16,10	4	132x72x3	134x73x10	148	48	3400	1584	9007741015820



CERNIERE ROBUSTE E FACILI DA USARE.

ROBUST AND EASY RUNNING HINGES.



COMPRESI 2 SUPPORTI PER 8 APPENDINI.

INCLUDING 2 HOLDERS FOR UP TO 8 CLOTHES HANGERS.



CHIUSURA PIATTA PER UN FACILE TRASPORTO E MINIMO INGOMBRO.

FOLDING FULLY FLAT FOR EASY STORAGE AND TRANSPORTATION.











RUOTE ROTABILI A 360° CON FRENI.

360° ROTATABLE WHEELS WITH BRAKES.



ACCIAIO VERNICIATO
PAINTED STEEL

Item	Weight Item / Master	Pcs. in Master	Packed Item Size a x b x c (cm)	Master Size a x b x c (cm)	Pallet Height	Pcs. in Pallet	Pcs. in 40' HC Container	Pcs. in Truck	EAN
									
ATHLETIC 4 CS92186	4,60/20,00	4	167x72x3	168x73x10	185	48	2660	1584	9007741015863

ASSI DA STIRO

2020

RB
ROBERT
INDUSTRIES
PRODUZIONE ARTICOLI CASALINGHI



01

QUALITA'

02

PRATICITA'

03

DESIGN



+39 030 9924412



Quinzano d'Oglio - Brescia - Italia



info@robertindustries.it

WWW.ROBERTINDUSTRIES.IT



BASIC STANDARD

ROBERT INDUSTRIES

2020

SIZE **S**

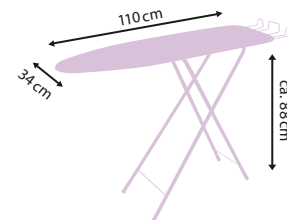

NORMA STANDARD.
STANDARD NORM.

POGGIA FERRO IN FILO.
WIRE IRON REST.

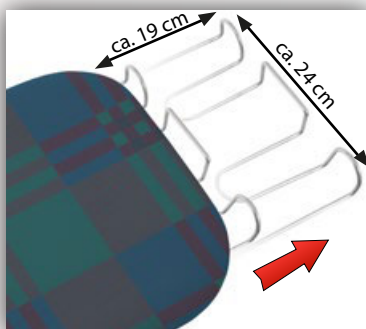

ACCIAIO VERNICIATO
PAINTED STEEL

Item	Weight Item / Master	Pcs. in Master	Packed Item Size a x b x c (cm)	Master Size a x b x c (cm)	Pallet Height	Pcs. in Pallet	Pcs. in 40' HC Container	Pcs. in Truck	EAN
BASIC STANDARD CS93611	3,20/20,60	6	35x5x119	121x37x25	160	54	3780	1782	9007741016261

SIZE **S**

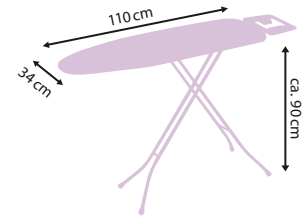

LEVA PRATICA E GRANDE.
PRACTICAL EXTRA LARGE LEVER.

POGGIA FERRO CON INSERTI IN SILICONE.
IRON REST WITH HEAT PROOF SILICONE PADS.

IRON REST WITH HEAT PROOF SILICONE PADS.

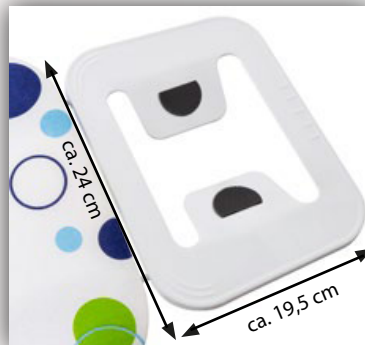
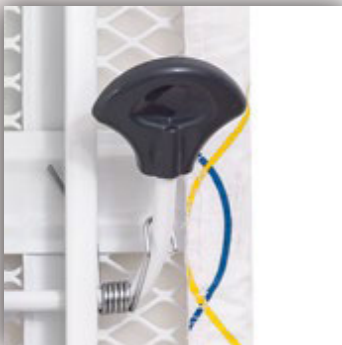

ACCIAIO VERNICIATO
PAINTED STEEL

Item	Weight Item / Master	Pcs. in Master	Packed Item Size a x b x c (cm)	Master Size a x b x c (cm)	Pallet Height	Pcs. in Pallet	Pcs. in 40' HC Container	Pcs. in Truck	EAN
BENNY CS93507	3,30/14,80	6	35x5x145	36X18X146	162	48	2976	1584	9007741003353

SIZE **M**

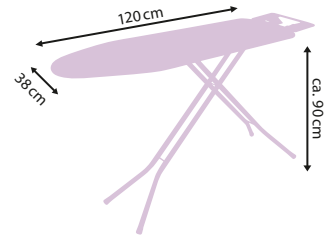

POGGIA FERRO CON INSERTI IN SILICONE.

IRON REST WITH HEAT PROOF SILICONE PADS.

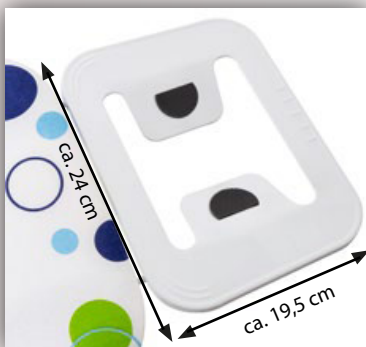

ACCIAIO VERNICIATO
PAINTED STEEL

Item	Weight Item / Master	Pcs. in Master	Packed Item Size a x b x c (cm)	Master Size a x b x c (cm)	Pallet Height	Pcs. in Pallet	Pcs. in 40' HC Container	Pcs. in Truck	EAN
SUPERSTANDARD BASIC CS95 150	3,98/8,60	2	5x159x38	40x11x160	177	36	2856	1188	9007741016667



MONDO DUE

ROBERT INDUSTRIES

2020

SIZE **M**

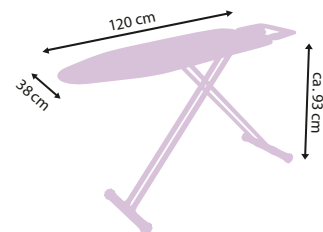

POGGIA FERRO CON INSERTI IN SILICONE.

PIEDI IN GOMMA ANTISCIVOLO.

IRON REST WITH HEAT PROOF SILICONE PADS.

ANTI-SLIP RUBBER FEET.



ACCIAIO VERNICIATO
PAINTED STEEL

Item	Weight Item / Master	Pcs. in Master	Packed Item Size a x b x c (cm)	Master Size a x b x c (cm)	Pallet Height	Pcs. in Pallet	Pcs. in 40' HC Container	Pcs. in Truck	EAN
MONDO DUE CS93572	5,50/12,50	2	38x7x161	166x44x15	181	38	1360	1188	9007741018357



MONDO UNO

ROBERT INDUSTRIES

2020

SIZE **L**

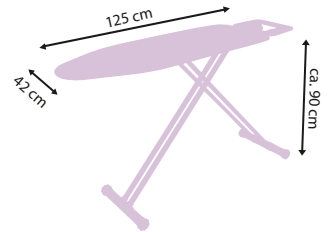

POGGIA FERRO CON INSERTI IN SILICONE.

IRON REST WITH HEAT PROOF SILICONE PADS.

PIEDI IN GOMMA ANTISCIVOLO.

ANTI-SLIP RUBBER FEET.



ACCIAIO VERNICIATO
PAINTED STEEL

Item	Weight Item / Master	Pcs. in Master	Packed Item Size a x b x c (cm)	Master Size a x b x c (cm)	Pallet Height	Pcs. in Pallet	Pcs. in 40' HC Container	Pcs. in Truck	EAN
MONDO UNO CS93573	6,50/14,40	2	38x7x161	170x46x15	183	18	990	594	9007741011433

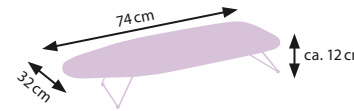

TABLE TOP

ROBERT INDUSTRIES

2020

SIZE XS



FACILE DA RIPORRE CON APPENDINO
PIEGHEVOLE INTEGRATO.

EASY STORAGE WITH INBUILT FOLDABLE
HANGER.



ACCIAIO VERNICIATO
PAINTED STEEL

Item	Weight Item / Master	Pcs. in Master	Packed Item Size a x b x c (cm)	Master Size a x b x c (cm)	Pallet Height	Pcs. in Pallet	Pcs. in 40' HC Container	Pcs. in Truck	EAN
TABLE TOP CS95159	1,10/11,80	10	30x5x73	75x33x31	195	324	14670	10692	9007741015011



SLEEVE BOARD

ROBERT INDUSTRIES

2020

SIZE XS

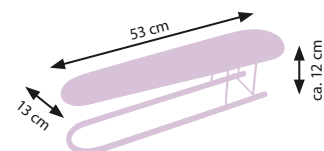

FACILE DA RIPORRE CON APPENDINO
PIEGHEVOLE INTEGRATO.

EASY STORAGE WITH INBUILT FOLDABLE
HANGER.



ACCIAIO VERNICIATO
PAINTED STEEL

Item	Weight Item / Master	Pcs. in Master	Packed Item Size a x b x c (cm)	Master Size a x b x c (cm)	Pallet Height	Pcs. in Pallet	Pcs. in 40' HC Container	Pcs. in Truck	EAN
SLEEVE BOARD CS 93097	0,70/8,00	10	65x13x6	57x33x25	166	500	16000	16500	9007741016629

SCALE E SGABELLI 2020

RB
**ROBERT
INDUSTRIES**
PRODUZIONE ARTICOLI CASALINGHI



01

QUALITA'

02

PRATICITA'

03

DESIGN



+39 030 9924412



Quinzano d'Oglio - Brescia - Italia



info@robertindustries.it

WWW.ROBERTINDUSTRIES.IT



PORTATA MASSIMA 100 KG

MAXIMUM CAPACITY 100 KG

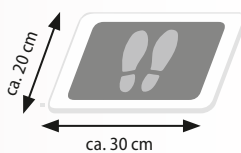

ACCIAIO VERNICIATO
 PAINTED STEEL

Item	Weight Item / Master	Pcs. in Master	Packed Item Size a x b x c (cm)	Master Size a x b x c (cm)	Pallet Height	Pcs. in Pallet	Pcs. in 40' HC Container	Pcs. in Truck	EAN
CLIMBER 2 1932/VD	4,30/26,00	1	51x4x90	51x4x90	145	100	5700	6600	8015010019326



PORTATA MASSIMA 100 KG

MAXIMUM CAPACITY 100 KG

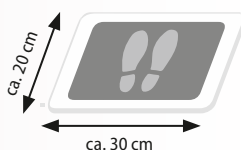

ACCIAIO VERNICIATO
 PAINTED STEEL

Item	Weight Item / Master	Pcs. in Master	Packed Item Size a x b x c (cm)	Master Size a x b x c (cm)	Pallet Height	Pcs. in Pallet	Pcs. in 40' HC Container	Pcs. in Truck	EAN
CLIMBER 3 1931/VD	6,20/24,00	1	51x4x115	51x4x115	130	80	4500	5280	8015010019319



PORTATA MASSIMA 100 KG

MAXIMUM CAPACITY 100 KG

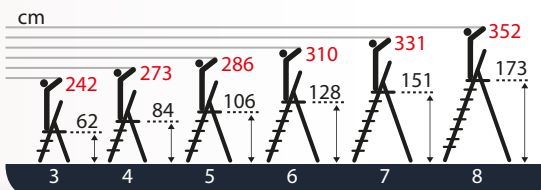

ACCIAIO VERNICIATO
PAINTED STEEL

Item	Weight Item/Master	Pcs. for Master	Packed Item Size a x b x c (cm)	Master Size a x b x c (cm)	Pallet Height (cm)	Pcs. for Pallet	Pcs. in 40"HC Container	Pcs. in Truck	EAN
Crystal Stell 3 Gradini 1933/VD	4,50	1	42 x 9 x 130,5	42 x 9 x 130,5	130,5	33	1915	1089	8015010019333
Crystal Stell 4 Gradini 1934/VD	5,50	1	45 x 9 x 153	45 x 9 x 153	153	30	1609	990	8015010019340
Crystal Stell 5 Gradini 1935/VD	6,50	1	48 x 9 x 175,5	48 x 9 x 175,5	175,5	30	1455	990	8015010019357
Crystal Stell 6 Gradini 1936/VD	7,50	1	51 x 9 x 198	51 x 9 x 198	198	30	1149	990	8015010019364
Crystal Stell 7 Gradini 1937/VD	8,50	1	54 x 9 x 220,5	54 x 9 x 220,5	220,5	30	996	990	8015010019371
Crystal Stell 8 Gradini 1938/VD	9,50	1	57 x 9 x 243	57 x 9 x 243	243	30	843	990	8015010019388



PORTATA MASSIMA 100 KG

MAXIMUM CAPACITY 100 KG

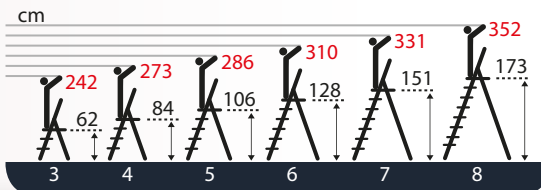
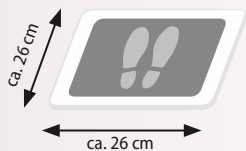

ALLUMINIO
ALUMINIUM

Item	Weight Item/Master	Pcs. for Master	Packed Item Size a x b x c (cm)	Master Size a x b x c (cm)	Pallet Height (cm)	Pcs. for Pallet	Pcs. in 40"HC Container	Pcs. in Truck	EAN
Crystal Aluminium 3 Gradini 1943/VD	3,30	1	42 x 9 x 130,5	42 x 9 x 130,5	130,5	22	1302	726	8015010019432
Crystal Aluminium 4 Gradini 1944/VD	3,80	1	45 x 9 x 153	45 x 9 x 153	153	20	996	660	8015010019449
Crystal Aluminium 5 Gradini 1945/VD	4,40	1	48 x 9 x 175,5	48 x 9 x 175,5	175,5	20	843	660	8015010019456
Crystal Aluminium 6 Gradini 1946/VD	5,30	1	51 x 9 x 198	51 x 9 x 198	198	20	689	660	8015010019463
Crystal Aluminium 7 Gradini 1947/VD	5,50	1	54 x 9 x 220,5	54 x 9 x 220,5	220,5	20	613	660	8015010019470
Crystal Aluminium 8 Gradini 1948/VD	5,80	1	57 x 9 x 243	57 x 9 x 243	243	20	460	660	8015010019487



ROBERT INDUSTRIES SRL Unipersonale
Via Luigi Cadorna 73 - 25027 - Quinzano d'Oglio (BS) - Italia
C.F./P.IVA IT 02203170226
T. +39 030 9924412 - F. +39 030 9924794
info@robertindustries.it